

MIGHTY WOLF

ASSEMBLY INSTRUCTIONS

PARTS CHECK LIST

Wrapped onto front beam:

- 3 – apron rods
- 2 – lease sticks (with holes)
- (2 – additional 37” dowels for Cherry Looms only)

Accessory pack:

- 1 – Brass Reed Hook
- 1 – Warp Beam Crank Handle
- 14 – 29” Apron Cords
- Maintenance and Warranty Manual

HARDWARE BAG

- 1 – $\frac{3}{8}$ ” cap nut and 1- $\frac{3}{8}$ ” washer for crank handle
- 2 – $\frac{1}{2}$ ” x $\frac{1}{4}$ ” beater pegs
- 2 – $\frac{3}{4}$ ” round head phillips screws
- 3 – extra $\frac{8}{32}$ ” hex nuts for harnesses

4-shaft looms:

- 800 – heddles
- 24 – tie-up cords

8-shaft or 4-now-4-later:

- 1000 – heddles
- 80 – tie-up cords

Please refer to the Maintenance and Warranty Manual for a labelled diagram of the entire loom.

UNFOLDING THE LOOM

1. Remove all plastic wrap from the loom.
2. Slightly loosen the two black plastic fold knobs on both sides of the loom. Generally, a single turn will do.

Note: Loosening the knobs all the way or removing them can cause the loom to collapse which could result in injury.

3. Stand at the side of the loom. Hold the front and rear beams together slightly. Pull the slide lock bars out toward the back of the loom.
4. Continue holding onto the front and rear beams

and allow the loom to unfold all the way. If there is a warp on the loom, you may need to step on the brake release pedal while unfolding the loom to loosen the warp.

5. When the loom is all the way down in the open position, push the knobs down to the bottom of the slots and tighten them.

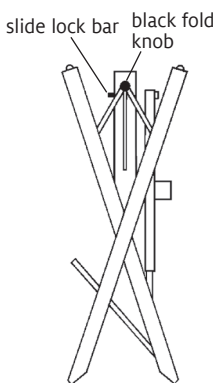

FOLDING AND UNFOLDING

FOLDING THE LOOM

1. To prevent treadles from dragging on the floor when the loom is folded, attach every treadle to at least one tie-up cord.
2. Loosen the two black knobs one full turn and pull them up to start folding the loom.
3. With one hand on the rear beam and one hand on the front beam, pull the loom together as far as it will go.
4. Tighten the knobs. Push the slide lock bars in towards the front of the loom.



Find out more at schachtspindle.com
Schacht Spindle Company 6101 Ben Place Boulder, CO 80301
p. 303.442.3212 f. 303.447.9273

© 2012 Schacht Spindle Company, Inc.

08.12

ATTACHING THE WARP BEAM CRANK HANDLE

Locate the washer, cap nut, and the wooden crank handle in the Accessory Bag. Place the 3/8" washer (W) and then the metal crank handle on the rod (R) with the wooden crank handle (H) facing out. Secure with the the 3/8" cap nut (N). To engage the crank for turning the warp beam, pull the hexagonal hole in the crank onto the cap nut. When weaving the crank should be pushed off of the cap nut.

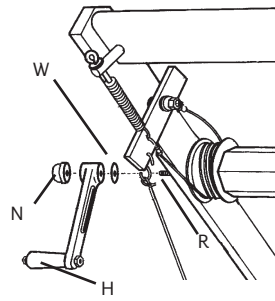

WARP BEAM CRANK HANDLE

ATTACHING THE APRON BARS

For Cherry Wolf Looms, see the special instructions for attaching the apron bars.

There is one cord for each hole in the cloth and warp beams. Insert one end of a cord through a hole in the beam and pull the cord through. Then insert the other end through the second hole in the end of the cord that you just put through the beam. Pull firmly on the cord to tighten (A). Repeat across the cloth beam and the warp beam.

To attach the apron bar to the apron cords, take a pinch of the cord about 4" from the end (B). Insert the pinched cord through the second hole in the cord. Pull on the pinched cord until a new loop forms that is large enough for the apron bar to slip through (C). Slide the apron bar through the loop (D) and pull tight. Repeat until all cords are attached to the apron bar. Attach the other apron bar to its beam in the same way.

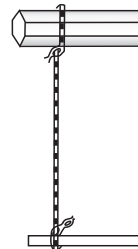
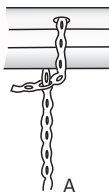

INSTALLING APRON CORDS

INSTALLING THE BEATER PEGS

Gently tap the slotted end of the beater pegs (P) into the holes on the outer side of each beater upright (U). From the inside of the beater side, fasten each peg with a 3/4" round-head phillips screw.

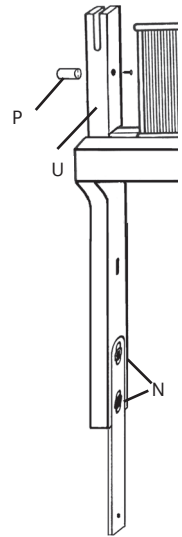

BEATER UPRIGHT

BEATER ADJUSTMENT

The height of your beater has been set at the factory to accommodate most weaving situations. However, if necessary, it can be adjusted up or down. To raise or lower the beater, loosen the two nuts (N) on the inside of each side of the metal beater pivot. Hold the beater at the

desired height and retighten the two nuts on one side and then the two nuts on the other side. Be sure that you have raised or lowered each side of the beater by the same amount.

BEATER PIN

The small metal pin attached to the right front leg is used to hold the beater upright during warping. Push the pin through the hole in the leg and then through the slot in the beater side. Pull out the beater pin and replace it in its holder before weaving or before folding the loom.

INSTALLING THE HEDDLES

Remove the shafts from the loom by removing the black rubber ring and unscrewing the small hex nut on the jack pin (located on the bottom inside of the shaft frame). Pull the harness straight up and out of the loom. When you put the shaft back in the loom, be sure to insert the jack pin back into the hole and secure it with the hex nut and rubber ring.

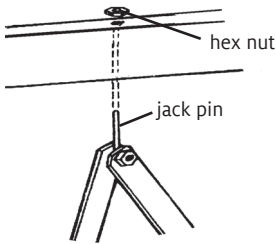

JACK PIN ATTACHMENT

There are 800 heddles for the 4-shaft Mighty Wolf and 1000 for 8-shaft and 4 now-4 later Mighty Wolfs. Without remov-

ing the heddles from their holding bar, count out the desired number of heddles for the first shaft and mark them with a tie around the center. Snap the black clip off one end of each holding bar by pressing down on the black button on the reverse side.

Lay a shaft flat and release both the heddle bars from the hooks that hold them in the middle of the shaft. Flex the heddle bars enough to remove one end from the slot in the side of the shaft frame. Remove the bars from the frame and lay them flat, next to the heddles on the holding bar. Carefully slide the marked group of heddles from the holding bar onto the heddle bars. Replace the heddle bars in the shaft frame. Place approximately half of the heddles at each end of the shaft and place the heddle bars back on the hooks. Put the shaft back in the loom, and secure the jack pin with the hex nut and rubber ring. Repeat for the other shafts.

TIE-UP CORDS

There is one tie-up cord for every lamm hole: 24 for a 4-shaft loom; 80 for an 8-shaft and 4 now-4 later looms. Loop one end of each tie-up cord through a hole in the lamm.

Tie the shafts to the treadle by slipping a tie-up cord into the slot in the treadle. Work from the front lamm to the rear lamm for each treadle. After you have

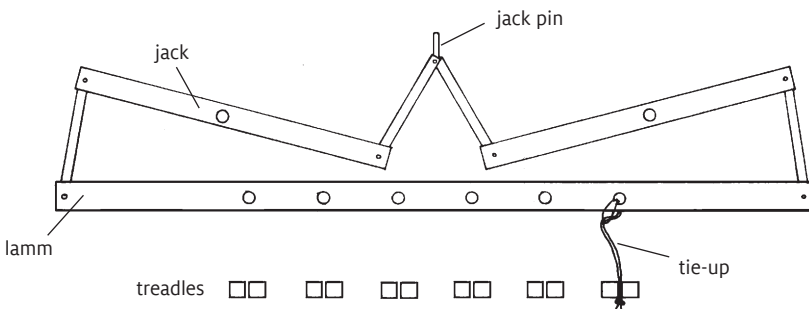

TREADLES AND JACK LAMM ASSEMBLY

completed your tie-up, check each treadle by pushing it all the way to the floor and releasing it, making sure that the knob of each tie-up cord is up against the treadle and that each cord hangs straight down to the treadle.

There is a 1/2" diameter depression on the underside of the top end of each treadle to prevent the tie-ups from slipping off when the loom is folded. The tie-ups should not be in this hole when weaving.

FRICTION BRAKE ADJUSTMENT

The friction brake can be adjusted by tightening or loosening the eyebolt (E). This will increase or decrease the tension on the spring (R), which will in turn increase or decrease the tension on the brake bar and the brake cable.

Always press down on the brake pedal while you are winding on the warp or advancing the warp on the cloth beam.

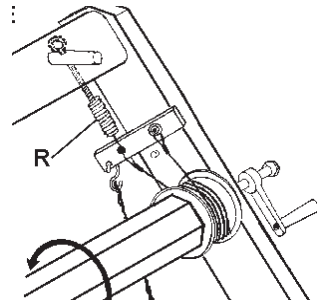

FRICTION BRAKE ADJUSTMENT

REMOVING THE BACK BEAM

The back beam can be removed for better access to the heddles while threading the loom. Loosen the black knobs on either side of the back beam, and lift the beam out. To replace the back beam, slide the beam back into the legs, and tighten the black knobs.

When moving the loom, be sure to lift it using the cloth and warp beams, not the front and back beams. ■

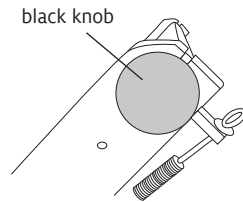

REMOVABLE BACK BEAM